

- Ⓒ Instruction Manual Cat. No. 8978
- Ⓕ Mode d'emploi Réf. 8978
- Ⓔ Manual de instrucciones Nº. 8978

## TELARIS SCHLEIFE



Contents	Page
1.0 Introduction / Scope of Supply .....	22
2.0 Transport and Storage.....	22
3.0 Safety Measures .....	23
4.0 General Information .....	24
5.0 Display Indications / Control Elements .....	25
6.0 Carrying out Measurements .....	26
6.1 Loop Measurement .....	26
6.2 Internal Mains Resistance Measurement.....	27
6.3 RPE/RN/RL Measurement.....	28
6.4 AC Voltage Measurement (UAC) .....	29
6.5 Frequency Measurement (f) .....	29
6.6 Contact Electrode .....	29
7.0 Display Indications.....	30
8.0 Storing Measurements .....	32
9.0 Deleting stored Measurement Data .....	32
10.0 Energy Management .....	32
11.0 Appropriate Usage .....	32
12.0 Maintenance .....	32
12.1 Cleaning .....	32
13.0 Battery Replacement.....	33
14.0 Calibration Interval .....	33
15.0 Technical Data.....	34

# Introduction / Scope of Supply / Transport and Storage

References marked on instrument or in instruction manual:



Warning of a potential danger, comply with instruction manual.



Reference. Please use utmost attention



Caution! Dangerous voltage. Danger of electrical shock.



Continuous double or reinforced insulation complies with Category II IEC 61140.



Symbol for the marking of electrical and electronic equipment (WEEE Directive 2002/96/EC)



Conformity symbol, the instrument complies with the valid directives. It complies with the EMC Directive (89/336/EEC). It also complies with the Low Voltage Directive (73/23/EEC).



The instruction manual contains information and references, necessary for safe operation and maintenance of the instrument.

Prior to using the instrument (commissioning / assembly) the user is kindly requested to thoroughly read the instruction manual and comply with it in all sections.



Failure to read the instruction manual or to comply with the warnings and references contained herein can result in serious bodily harm or instrument damage.

## 1.0 Introduction

You have purchased a high quality measurement instrument of Ch. BEHA GmbH which will allow you to carry out measurement over a long period of time. The company Ch. BEHA GmbH is a member of the world wide operating BEHA Group with its head office in Glottertal/Schwarzwald which also houses our development centre. The BEHA Group is a leading organisation for Test and Measuring Instruments.

The instrument UNITEST TELARIS SCHLEIFE is characterised by the following features:

- A unit designed to allow the user to quickly establish earth loop impedance, mains internal resistance and prospective short circuit current.
- Enables the user to measure the individual conductor resistances independently: protective conductor resistance, phase resistance and neutral conductor resistance.
- Designed to test the earth loop resistance without tripping any RCD
- Designed to test AC voltages up to 300V AC.
- Designed to test frequency ranges up to 200 Hz.
- Includes a built-in memory capability allowing the user to store up to 250 test results.
- Supplied with an infrared/ RS 232 serial port for transferring test data or printing out results via the PC.
- Enables the user to pre-select the maximum permissible contact voltage.
- Includes a clear and large LCD display providing the user with an optimum visual indication of both test values and limits
- Includes an integrated energy management system with auto-power-off function to ensure optimum battery usage.
- Supplied complete with standard carrying case.
- Designed to meet the constructional standards IEC 61010, IEC 61557-1/3, EN 61557-1/3, DIN VDE 0413, Part 3.

## Scope of Supply

- 1 pc TELARIS SCHLEIFE
- 1 pc test lead
- 1 pc measuring lead
- 1 pc alligator clamps
- 3 pcs test probe
- 1 pc battery 9V, IEC 6LR61
- 1 pc carrying case
- 1 pc instruction manual

## 2.0 Transport and Storage

Please keep the original packaging for later transport, e.g. for calibration. Any transport damage due to faulty packaging will be excluded from warranty claims.

 In order to avoid instrument damage, it is advised to remove batteries when not using the instrument over a certain period of time. However, should the instrument be contaminated by leaking battery cells, you are kindly requested to return it to the factory for cleaning and inspection.

Instruments must be stored in dry and enclosed areas. In the case of an instrument being transported in extreme temperatures, a recovery time of minimum 2 hours is required prior to instrument operation.

### 3.0 Safety Measures

The UNITEST TELARIS SCHLEIFE has been designed and checked in accordance with the safety regulations for Electronic Test and Measurement Instruments EN 61010 and IEC 1010, and left our factory in a safe and perfect condition. To maintain this condition the user must pay attention to the safety references contained in this instruction manual.

 The respective accident prevention regulations established by the professional associations regarding electrical systems and equipment must be strictly met for all tasks.

 In order to avoid electrical shock, the valid safety and VDE regulations regarding excessive contact voltages must receive the utmost attention, when working with voltages exceeding 120V (60V) DC or 50V (25V)rms AC. The values in brackets are valid for limited ranges (eg for medicine and agriculture).

 If the operator's safety can no longer be guaranteed, the instrument is to be put out of service and protected against use. The safety is no longer guaranteed, if the instrument:

- shows obvious damage
- does not carry out the desired measurement.
- has been stored for too long under unfavourable conditions.
- has been subjected to mechanical stress during transport.

 The instrument may only be used within the operating ranges as specified in the technical data section.

 Avoid any heating up of the instrument by direct sunlight to ensure perfect functioning and long instrument life.

 The Earth Loop Resistance Measurement Instrument complies with the overvoltage class CAT III / 300V and may only be used for mains systems of maximum 230 V (fused at maximum 16 A).

 Only use the mains cable supplied. The unit was calibrated with this cable and only in this way can the resistance values measured be exactly indicated.

## 4.0 General Information

The loop impedance (L-PE / loop impedance) is understood as the sum of all resistance values within a current loop, consisting of the resistors of the current source, the external conductor of the current source up to the measurement point and the return line (PE conductor) until the other current source pole. The measurement determines the loop impedance between external conductor and the PE conductor. The Loop impedance value is measured by short-term mains loading.

Additionally, the instrument TELARIS Loop allows the user to test the mains internal resistance measurement (L-N). This measurement is not required by DIN VDE [German Standard], however it is considered as important and valuable support in practical applications e.g. for evaluating an installation as well as for trouble shooting.

Simultaneously to measurement, the instrument TELARIS SCHLEIFE determines (by calculation) the short-circuit current. The short-circuit current must be known to guarantee that an excess current release having been switched in series can trigger at an appropriate current level and thus at sufficient speed in the event of short-circuit.

### Terms:

Loop Impedance (ZL):

Sum of impedance values within a current loop (between the L and PE conductor).

Internal Resistance (RI):

Sum of resistance values within a current loop (between the L and N conductor).

RL: Phase resistance

RPE: Protective conductor resistance

RN: Neutral conductor

RE: Earth-Resistance

Short-Circuit Current (IPSC):

Occurring current flow in the event of short circuit.

Specified Threshold Value of Contact Voltage (UL):

Peak value of contact voltage (Limit), which may be maintained without time limit under specific environmental influence and corresponding to an rms value of 25V / 50V AC

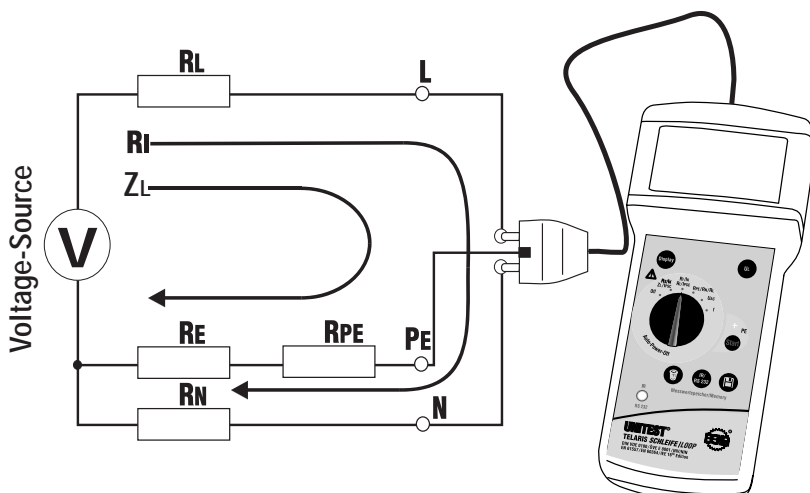

## 5.0 Display Indications and Control Elements

### Display Indications

- 1 Attention, warning symbol
- 2 "Limit": exceeding the threshold value
- 3 "UB>UL": contact voltage present exceeds the pre-set limit (25V or 50V)
- 4 "Temp": internal temperature protection has triggered
- 5 Symbol for "Socket Error"
- 6 Symbol "Reverse Mains Plug"
- 7 Display of units (refer to 12)
- 8 Symbol for "Battery status"
- 9 Measurement value display 31/2 display
- 10 Limit for Contact voltage value
- 11 Symbol for Memory assignment
- 12 Measurement function display

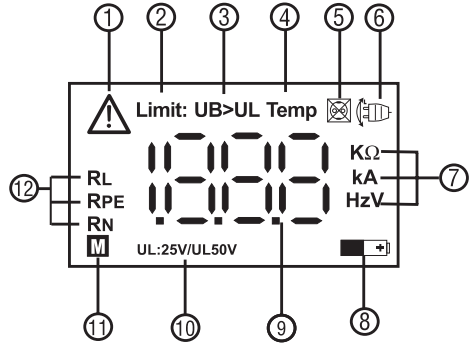

### Control Elements

- 13 Mains connector for mains lead /Test lead
- 14 LCD
- 15 Key "UL" : 50V/25V (25V for medical and agricultural uses)
- 16 Contact electrode
- 17 Measurement function switch: off  
ZL/IPSC - Loop impedance / short-circuit current  
RI/IPSC -Internal resistance / short-circuit current  
RPE / RN / RL -  
UAC - AC voltage  
f - mains frequency
- 18 Key Start: starting measurement
- 19 Key Store: to store measurement values
- 20 Key IR/RS 232: to transfer stored measurement values to a PC
- 21 Key Clear:  
to delete the total memory  
to delete the individual measurement values  
to display total number of stored measurement values
- 22 Infrared interface: to transfer the stored measurement values only with Serial-Port (Catr-No: 1204)
- 23 Key Display to display different measurement values (resistance measurement ranges)
- 24 Battery Case

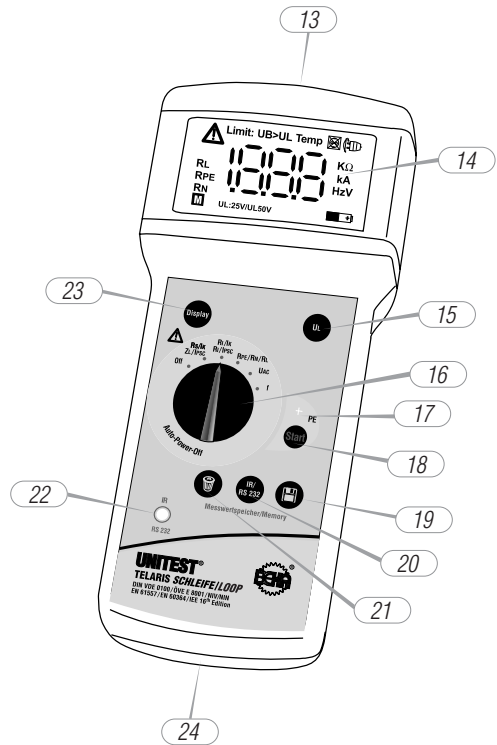



# Carrying out Measurements

## 6.0 Carrying out Measurements

 Prior to any measurement, test the instrument for perfect functioning by using a functional EUT. This could be a correctly wired socket of which perfect functioni is known.

 To obtain precise measurement results, switch off all loads or disconnect them from the mains.

 An exact measurement may only be carried out using the supplied test lead / mains lead. The instrument has been calibrated with this cable. If other cables are employed, the measurement accuracy can no longer be guaranteed.



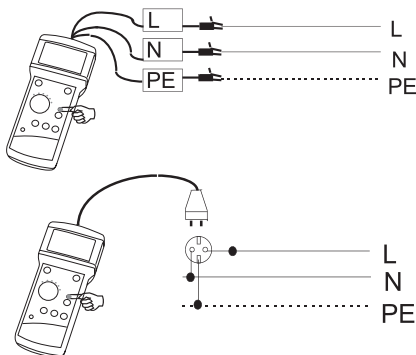

 If several measurements are carried out during a short period the temperature monitor is triggered. After a short cooling-down period, the measurements may be resumed.

 For resistance measurements in compliance with 6.1, 6.2 and 6.3, the ground conductor must not be live in order to comply with the respective specifications.







## 6.1 Loop Impedance Measurement /

### Short-Circuit Current Measurement

-  Connect the mains lead to the mains connector (13).
-  Select the measurement function ZL/IPSC via the function switch (17).
-  Connect the test cables / mains plug to UUT / socket by respecting correct polarity
-  Set a voltage contact limit using the key (15) of the screen.

 The socket is continuously monitored for perfect function. If the symbol (6) "Reverse mains plug" is displayed, the plug has to be turned or the connection N and L of the three-pole test lead have to be reversed. If the symbol "Socket Error" (5) is displayed, an internal mains error exists. If the voltage between N and PE exceeds the selected (50V/25V), "UB>UL" (3) is displayed.

 For a complete socket test the contact electrode (16) must be touched, and the LC-display must be watched. If the symbol "socket error" (5) is displayed a PE error exists.

-  Press key "Start" (18)
-  Wait for approx. 5 seconds, during this the display shows "-"
-  Read the measurement result on display.
-  By pressing the key "Display" (23) you may now select the different measurement values.

 If the RL conductor resistance exceeds 19.99  $\Omega$ , the measurement is interrupted and the message "Attention (1) + Limit (2) + RL" is displayed.

 If the RN conductor resistance exceeds 19.99 $\Omega$ , the measurement is interrupted. The message "Attention (1) + Limit (2) + RN" is displayed.

 If the RPE resistance of PE conductor exceeds 1999 $\Omega$ , the message "Attention (1) + Limit (2) + RN" is displayed.

 If a contact voltage UB is generated between N and PE during the active measurement and exceeding the selected contact voltage limit UL, the measurement is interrupted and the symbol "UB>UL" (3) is displayed.

 If a measurement has been interrupted due to contact voltage limit UL excess, the symbol "UB>UL" (3) disappears at the same time as the mains plug has been disconnected from the socket and connected to a socket in perfect working condition. During data saving, the UB>UL error will be saved.

 Please also refer to Chapter 7.0



 Option to save measurement results pressing the key "Store" (19).

 If the defective condition of a socket has to be saved, first press the key "Start" (18). After the acoustic alarm signal the key "Store" (19) may be pressed.

## 6.2 Internal Mains Resistance Measurement





### Short-Circuit Current Measurement

 To obtain precise measurement results, switch off all loads or disconnect them from the mains.

-  Connect the mains lead to the mains connector (13)
-  Select measurement function via the function switch (17).
-  Select contact voltage limit by means of the key "UL" (15) in display.

 The socket is continuously monitored for perfect functioning. If the symbol (6) "reverse mains plug" is displayed, the plug has to be turned or the connection N and L of the three-pole test lead have to be reversed. If the symbol "Socket Error" (5) is displayed, an internal mains error exists. If the voltage between N and PE exceeds the selected (50V/25V), "UB>UL" (3) is displayed.

 By touching the contact electrode (16) the contact voltage limit (chapter 6.6) may now be tested. If the symbol "socket error" (5) is displayed, a PE-error exists.

-  Press key "Start" (18).
-  Wait for approx. 3 seconds, during this the display shows "-"
-  Read the measurement result on the display.
-  pressing the key "Display" (23) you may now select the different measurement variables (RI / IPSC)

 If the internal resistance exceeds 19.99  $\Omega$ , the message "Attention (1) + Limit (2)" is displayed.

 Also refer to chapter 7.0.

 Possibility to store measurement results by pressing the key „Store" (19).

 If the defective condition of a socket has to be saved, first press the key "Start" (18). After the acoustic alarm signal the key "Store" (19) may be pressed.



# Carrying out Measurements

## 6.3 RPE / RN / RL Measurement



To obtain precise measurement results, switch off all loads or disconnect them from the mains.



Connect the mains lead to the mains connector (13)



Select the measurement function via the function switch (17).



Select the contact voltage by means of the key "UL" (15) on the display.



The socket is continuously checked for perfect functioning. If the symbol (6) "Reverse mains plug" is displayed, the plug has to be turned or the connection N and L of the three-pole test lead have to be reversed. If the symbol for "Socket Error" (5) is displayed, an internal mains error exists. If the voltage between N and PE exceeds the selected contact voltage limit (50V/25V), "UB>UL" (3) is displayed.



By touching the contact electrode (16) the contact voltage limit (chapter 6.6) may now be tested. If the symbol "Socket Error" (5) is displayed, a PE-error exists.



Press key "Start" (18).



Wait for approx. 5 seconds during this the display shows "-".



Read the measurement result on the display.



By pressing the key "Display" (23) you may now select between the different measurement variables.



If a value exceeds the measurement limit, the Attention symbol appears. If this result is selected with the key "Display", the Attention Symbol and "Limit" are displayed.



If the value RN exceeds the measurement Limit, the outrun of RL is displayed too, because RN is necessary to get RL.



If the value for RPE shows 0,00Ω this could be a Note of an exceeding interfering voltage.



If a contact voltage UB is generated between N and PE during active measurement exceeding the selected contact voltage limit UL, the measurement is interrupted and the symbol "UB>UL" (3) is displayed.



If a measurement has been interrupted due to contact voltage limit UL excess, the symbol "UB>UL" (3) disappears at the same time as the mains plug has been disconnected from the socket. During data saving, the UB>UL error will be saved.



Also refer to chapter 7.0.









Possibility to store measurement results by pressing the key „Store" (19).





If the defective condition of a socket has to be saved, first press the key "Start" (18). After the acoustic alarm signal the key "Store" (19) may be pressed.

## 6.4 AC Voltage Measurement

 Never apply voltages exceeding 300V to input sockets.

-  Connect mains lead (13) to the mains connector
-  Select function UAC via the function switch (17)
-  Select the contact voltage by means of key (15) in display
-  Connect the the test leads /mains plug to UUT
-  Read the measurement result on the display





 If the voltage exceeds 300V, the message "Attention (1) + Limit (2) " is displayed. In this instance, immediately disconnect the measurement instrument from UUT.

 Also refer to chapter 7.0.

 No possibility to store the measurement results.

## 6.5 Frequency Measurement

 Never apply tvoltages exceeding 300V to input sockets.

-  Connect the mains lead to the mains connector (13)
-  Select the function f via the function switch (17)
-  Connect the the test leads /mains plug to UUT
-  Read the measurement result on the display

 Also refer to chapter 7.0.

 No possibility to store the measurement results.

## 6.6 Contact Electrode

Measurement of the present contact voltage is carried out after setting the contact voltage limit. By touching the contact electrode, exceeding the limit is automatically indicated (>25V or 50V).

# Display Indications

## 7.0 Display Indications

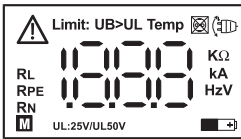

All segments are illuminated

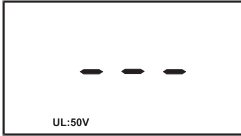

The instrument is ready to carry out measurements.  
Contact voltage limit 50V

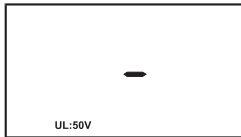

Active measurement  
Contact voltage limit 50V



Resistance measurement  
RPE/ RN/ RL  
RPE = 1.88 Ω  
Contact voltage limit 50 V

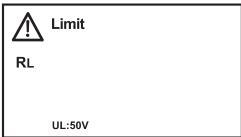

Resistance measurement  
RPE/ RN/ RL  
RL exceeded  
Contact voltage limit 50 V



Resistance measurement  
Ri/Ipsc  
IPSC = 88A  
Contact voltage limit 25 V

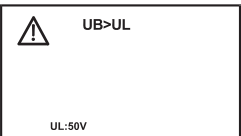

Resistance measurement  
Zi/ Ipsc  
Contact voltage limit exceeded  
Contact voltage limit 50 V

Resistance measurement  
Zi/ Ipsc  
ZL = 2,88 Ω  
Contact voltage limit 50 V



Resistance measurement  
Zi/ Ipsc  
RL excessive (>19,99 Ω)  
Measurement is interrupted  
Contact voltage limit 50 V

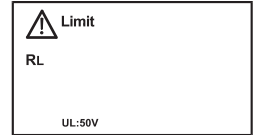

Resistance measurement  
Zi/ Ipsc  
ZL excessive (>1,999kΩ)  
Contact voltage limit 50 V

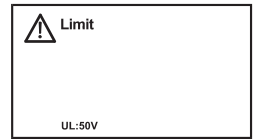

Socket error  
Nominal voltage tolerance exceeded  
Contact voltage limit 50 V

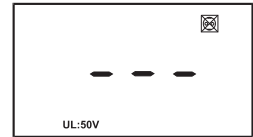

Socket Error  
Faulty socket wiring (during contact with PE electrode)  
Contact voltage limit 50 V

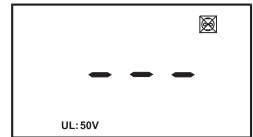

PE Error  
Contact voltage limit 50 V  
Contact voltage limit exceeded

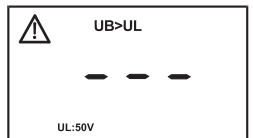

Battery / temperature / memory display  
Battery nearly empty  
Excessive internal temperature  
Memory data

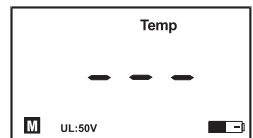

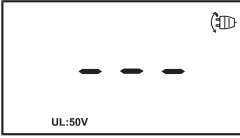

**turn plug**  
turn plug / exchange L-N



**Frequency measurement f**  
50Hz

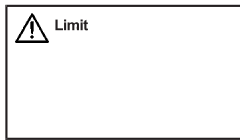

**Frequency measurement**  
Frequency below 10Hz or  
above 200 Hz



**Voltage measurement**  
U AC 230 V

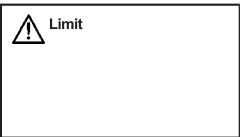

**Voltage measurement V AC**  
Voltage above 300V



**Memory address assignment**  
Memory address number 8

## 8.0 Storing Measurement Result

Possibility to store measurement values by means of the key „Store“ (19) after completion of measurement. Altogether, 250 measurement values may be saved. Proceed as follows:

- ▶ Carry out measurement
- ▶ Read measurement value on display.
- ▶ Save measurement result by pressing key „Store“ (19).
- ▶ Upon completion of storing, a short signal is audible and the symbol „M“ (11) appears in the display for memory location.

☞ In case of a full memory, the symbol „M“ blinks. Storing another value impossible.

☞ The stored data is maintained even when the instrument is switched off or during battery replacement.

☞ Double storing is impossible ! A double beep signal is audible

☞ Measurement results may only be stored in the resistance measurement ranges.

Additionally, all stored measurement data may be transferred to the PC (data archive) by means of an infrared interface (22). For this purpose, the interface adapter, available as optional feature is required. Please refer to the instructions of the interface adapter.

## 9.0 Deleting stored Measurement Data /

### Display of All Memory Entries

Possibility to delete data by using key „Clear“ (21). Furthermore, it is possible to display the total number of measurement value entries on the display:

### Display of Total Number of Measurement Value Entries:

- ▶ Set function switch (17) to one of the 5 measurement ranges
- ▶ Briefly press the key „Clear“ (21). A short beep signal is audible
- ▶ The total number of all measurement values saved is displayed
- ▶ The display disappears after 2 seconds

### Delete the Last Memorised Measurement Value:

- ▶ Set function switch (17) to one of the 5 functions
- ▶ Press key „Clear“ (21) for approx. 2 seconds.
- ▶ A short beep signal is audible
- ▶ After 2 seconds, a further beep signal is audible and the number of the remaining stored data is displayed
- ▶ Get down from the key “Clear” (21)

### Deleting all Stored Measurement Values:

- ▶ Set function switch (17) to one of the 5 functions
- ▶ Press key „Clear“ (21) for approx. 5 seconds.
- ▶ Three short beep signals are audible.
- ▶ „0“ appears on the display. The memory is completely deleted, the „M“ (11) symbol in the display disappears.

## 10.0 Energy Management

Approximately 5 minutes after the last key operation, the instrument switches off automatically (auto-power-off). To switch the instrument on again, turn the rotary switch from the „OFF“ position to the desired function. If the Battery is almost dead, the symbol (8) appears in the indication. The piece of equipment works furthermore, however without claim on retention of the specifications. If the battery discharges further, the piece of equipment switches itself off when reaching the minimal battery tension. At empty battery cannot switch the piece of equipment on.

## 11.0 Appropriate Usage

The instrument may only be used under those conditions and for those purposes for which it was built. For this reason, in particular the safety references (chapter 3.0), as well as the technical data including environmental conditions (chapter 15.0) and the usage in dry environments must be followed at all times.

 When modifying or changing the instrument, the operational safety can no longer be guaranteed.

 If the battery case is open, the instrument must not be connected to the measurements circuits

## 12.0 Maintenance

When using the instrument in compliance with the instruction manual, no special maintenance is required.







## 12.1 Cleaning

If the instrument is dirty after daily usage, it is advised to clean it by using a damp cloth and a mild household detergent. Prior to cleaning, ensure that the instrument is switched off and disconnected from the external voltage supply and any other instruments connected (such as EUT, control instruments, etc.).



 Never use acid detergents or dissolvents for cleaning.

## 13.0 Battery Replacement

 Prior to battery replacement, disconnect the instrument from the connected measurement circuits.

-  If the battery symbol (8) appears in the display, proceed with battery replacement.
-  Switch off the instrument via the function witch (17).
-  Loosen the screws on the instrument rear.
-  Lift the battery case cover (by slightly hitting the instrument in the palm of your hand).
-  Remove the discharged batteries.
-  Insert new batteries and ensure there is correct polarity.

 Only use batteries in compliance with the specifications in the technical data section. (Type 6LR61 / Block 9V).

-  Replace the battery case cover and retighten the screws.
-  The instrument is now ready for further measurements.

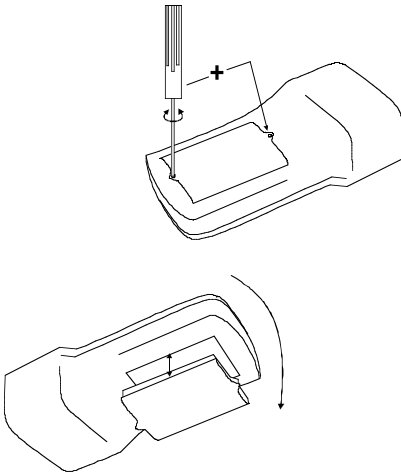

 Never try to disassemble battery cells. Never throw a battery into a fire as this could lead to an explosion. Never expose batteries to humidity.

Please consider your environment when you dispose of your used batteries. They belong in a rubbish dump for hazardous waste. In most cases, the batteries can be returned to their point of sale.

Please, comply with the appropriate regulations concerning the return, recycling and disposal of used batteries and accumulators.

 The instrument is not allowed to be used with an open battery case.

 If an instrument is not used over an extended period of time, the accumulators or batteries must be removed. Should the instrument be contaminated by leaking battery cells, the instrument has to be returned for cleaning and inspection to the factory.

## 14.0 Calibration Interval

The instrument has to be periodically calibrated by our service department in order to ensure the specified accuracy of the measurement results. We recommend a calibration interval of one year.

# Technical Data

## 15.0 Technical Data

Display: .....LCD, 3 1/2 digit  
 Reference range: .....+17°C ... 27°C, max. 70 % rel. humidity  
 Mains voltage: .....230V + 10%/-15%  
 Mains frequency: .....50-60 Hz  
 Test current (ZL, RI, RN, RL, RPE): .....approx. 6 A/ 5mA

for all resistance ranges applies:  
 test current / time (RL, RN, RI): .....ca. 7,5A / 60ms AC  
 test current / time (ZL, RPE): .....ca. 5 mA / 3s DC  
 Contact voltage limit: .....25V/50V  
 protective earth conductor must be free of interfering voltage.

### Loop Impedance ZL

Range	Resolution	Tolerance
0.60Ω-19.99Ω	0.01Ω	±8% ±8Digit
20.0Ω-199.9Ω	0.1Ω	
200kΩ-1.000 kΩ	0.001kΩ	± 5 % ±5Digit

### Internal Resistance RI

Range	Resolution	Tolerance
0.60 Ω-10.00Ω	0.01Ω	± 6 % ± 6 Digit

### Resistance Neutral Conductor RN

Range	Resolution	Tolerance
0.60 Ω-10.00Ω	0.01Ω	±6% ±8Digit

### Resistance Protective Conductor RPE

Range	Resolution	Tolerance
0.60Ω-19.99Ω	0.01Ω	± 7 % ±8 Digit
20.0Ω-199.9Ω	0.1Ω	
200kΩ-1.000 kΩ	0.001kΩ	± 5 % ±5Digit

### Resistance Phase Conductor RL

Range	Resolution	Tolerance
0.60Ω-10.00Ω	0.01Ω	+ (6% + 8D)

Prospective Short-Circuit Current Measurement (ZL/IPSC and RI/IPSC)

Range	Resolution
0...2kA1	Amathematical
19.9kA10	Acalculation

$$IPSC = \frac{UAC}{ZL}$$

$$Ik = \frac{UAC}{RI}$$

Table with limit values for short-circuit currents for fuses according to DIN VDE 0636 characteristics gL:

Nominal current during	Min. display for safe tripping 5s (in Amps)	Min. display for safe tripping during 0.2s (in Amps)
6A	32	67
10A	53	110
16A	81	163
25A	135	312
40A	228	490
63A	414	979
100A	714	-

### AC Voltage UAC

Range	Resolution	Tolerance	Overload Protection
5...300 V AC	1V	± 5 % ±5Digit	400V / RI = 1 MΩ

### Mains Frequency f

Range	Resolution	Tolerance	Overload Protection
10..200Hz	0,1 Hz	±(1% rdg. +2 Digit)	400V / RI = 1 MΩ

Contact voltage detection:

UL = 25V .....25V                  -5% /+15%

UL = 50V .....50V                  -5% /+15%

\*For large mains voltage fluctuations during measurements, the measurement error may increase.

Auto power off: .....after approx. 5 min.

Power supply: .....1x9V block, 6LR61

current consumiom: .....approx. 20mA

Battery life: .....at average usage, approx. 1 year

Fuse: .....1A / 250V slow blow 5x20mmI

Dimensions (LxWxH): .....235x103x70mm (without plug)

Weight: .....500g incl battery

Environmental conditions:

Relative humidity: .....max 80%, non condensing

Overvoltage category: .....CAT III / 300V to ground

Pollution degree: .....2

Protective class / degree: .....II / IP50

Height above MSL: .....up to 2000m

Temperature ranges (operating): .....0°C ... 40°C

Temperature ranges (storage): .....-20°C ... +70°C

### 24 month Warranty

UNITEST instruments are subject to strict quality control. However, should the instrument function improperly during daily use, you are protected by our 24 months warranty (valid only with invoice). We will repair free of charge any defects in workmanship or material, provided the instrument is returned unopened and unaltered i.e. with undamaged warranty label. Any damage due to dropping or incorrect handling are not covered by the warranty. If the instrument shows failure following expiration of warranty, our service department can offer you a quick and economical repair.

Subject to change without notice!





Reg.No. 3335

## **CH. BEHA GmbH**

**Elektronik · Elektrotechnik**

In den Engematten 14  
79286 Glotttartal/Germany  
Tel.: +49 (0) 76 84 / 80 09 - 0  
Fax: +49 (0) 76 84 / 80 09 - 410  
Techn. Hotline: +49 (0) 76 84 / 80 09 - 429  
internet: <http://www.beha.com>  
e-mail: [info@beha.de](mailto:info@beha.de)