

Di-LOG

...measurably better

Operating Instructions for AC TRMS CLAMP METER



Instruction Manual
for DL6413 (v1.1)

EN
61010-1

CAT IV
600V

Please read this manual before switching the meter on. Important safety information included.

Contents	Page
I. Certificate of Conformity	2
II. Safety	3/4
III. Instrument & Manual Symbols	5
IV. Description	6
V. Meter Description	7
VI. Symbols Used on LCD Display	8
VII. Detailed Specifications: Range & Accuracy	9/10
1. General Specifications	10
2. Operation	11
2.1. AC Current Measurements	11
4. AC/DC Voltage Measurements	12
5. Resistance Measurements	12
6. Continuity Measurements	12
7. Diode Measurements	13
8. Capacitance Measurement	13
9. Frequency or % Duty Cycle Measurements	13
10. Temperature Measurements	14
11. Non-Contact AC Voltage Measurements	14/15
12. MODE Button	15
13. RANGE Button	15
14. MAX/MIN Button	16
15. REL/Backlight Button	16
16. Data Hold/Flashlight Button	17
17. Battery Replacement	17
18. Maintenance & Cleaning	17
19. Warranty & Calibration	18

I. Certificate of conformity

As the manufacturer of the instrument listed below, we declare under our sole responsibility that the product:

Di-LOG DL6413

To which this declaration relates is in conformity with the relevant clauses of the following standards:

LVD & EMC

EN 61326

EN 61010-1

EN 61010-02-032

EN 61010-02-033

The instrument has been factory-calibrated during its manufacturing process, ensuring it fully conforms to our rigorous quality assurance procedures. This guarantees exceptional accuracy and reliability for all your measurement needs.

The safety and performance of this instrument is assured when operated within the specifications in this instruction manual.

The product identified above conforms to the requirements of the UK and EU directives for electrical Equipment (Safety) Regulations 2016 (Low Voltage Directive 2014/35/EU) and the Electromagnetic Compatibility Regulations 2016 (EMC Directive 2014/30/EU).

II. Safety

International Safety Symbol

This symbol, adjacent to another symbol or terminal, indicates the user must refer to the manual for further information.

Hazardous Voltage Symbol

This symbol, adjacent to a terminal, indicates that under normal use, hazardous voltages may be present.

Double insulation symbol

Safety Notices

- Do not exceed the maximum allowable input range of any function.
- Do not apply voltage to meter when resistance function is selected.
- Set the function switch OFF when the meter is not in use.

WARNINGS!

- Set function switch to the appropriate position before measuring.
- When measuring voltage, do not switch the meter to current or resistance modes.
- When changing ranges using the selector switch always disconnect the test leads from the circuit under test.
- Do not exceed the maximum rated input limits.

CAUTIONS

- Improper use of this meter can cause damage, shock, injury or death. Read and understand this user manual before operating the meter.
- Always remove the test leads before replacing the battery.
- Inspect the condition of the test leads and the meter itself for any damage before operating the meter. Repair or replace any damage before use.
- Use great care when making measurements if the voltages are greater than 25VAC RMS or 35VDC. These voltages are considered a shock hazard.
- Remove the battery if the meter is to be stored for long periods.
- Always discharge capacitors and remove power from the device under test before performing Diode, Resistance or Continuity tests.
- Voltage checks on electrical outlets can be difficult and misleading because of the uncertainty of connection to the recessed electrical contacts. Other means should be used to ensure that the terminals are not Live following the Safe Isolation Procedure as set out in the Electricity at Work Regulation 1989.

II. Safety (Continued)

- If the equipment is used in a manner not specified by the manufacturer, the protection provided by the equipment may be impaired.

It is important to check the state of the battery before use and to replace it if necessary.

The meter has been designed in accordance with the safety regulations for electronic measuring instruments:

- **EN 61326**
- **EN 61010-1**
- **EN 61010-02-032**
- **EN 61010-02-033**

The meter may only be inspected and repaired by a qualified service technician for calibration and repair, please refer to section 19 for further information.

Please observe the below maximum input limits on all ranges:

Input Limit Function	Maximum Input
A - AC/DC	1000A
V - AC/DC	1000V AC/DC
Frequency, Resistance, Diode & Continuity	1000V AC/DC
Capacitance Test & Temperature	1000V AC/DC

III. Instrument & Manual Symbols

Symbols displayed on the instrument and in the instruction manual:



Warning! Warns of potential danger, and to comply with the instruction manual.



Caution! Dangerous voltage, potential risk of electrical shock.



Equipment protected throughout by double or reinforced insulation. Complies with IEC 536, class II



Suitable for live working.



CE CE Symbol of conformity confirms conformity with relevant EU directives. The meter complies with EMC directives (2004/08/ EC), the Low Voltage Directive (described in the standard EN 61010-1)



UKCA UKCA Symbol of conformity confirms conformity with relevant UK regulations. The meter complies with EMC regulations (SI 2016 No. 1091), the Low Voltage Regulation (described in the standard EN 61010-1)



The DL6413 meets the standard (2012/19/EU) WEEE Directive in the UK & EU. This marking indicates that this product should not be disposed with other household wastes throughout the EC. To prevent possible harm to the environment or human health from uncontrolled waste disposal, recycle it responsibly to promote the sustainable reuse of material resources. To return your used device, please use your local authority return and collection systems or contact the retailer where the product was purchased. They can take this product for environmental safe recycling.



The instruction manual contains information and references, necessary for safe operation and maintenance of the instrument. Prior to using the instrument, the user is kindly requested to thoroughly read the instruction manual and comply with it in all sections.



Failure to read the instruction manual or to follow the warnings and references contained herein can result in serious bodily injury or instrument damage. The respective accident prevention regulations established by the professional associations are to be strictly enforced at all times.

IV. Description: DL6413 Specification

TRMS Clamp Meter Specification	
	DL6413
Voltage range	0.001V - 1000V AC
	1mV - 1000V DC
Current range	0.1A - 1000A AC
Resistance	0.1Ω - 40MΩ
Capacitance	0.01nF - 100mF
Temperature	-20.0°C to 1000°C
	-4.0°F to 1832°F
Frequency/Duty Cycle	9.999Hz- 99.99kHz / 10% - 90%
Non-contact Voltage	1000V AC
Audible Continuity	<50Ω @ <0.5mA
Auto Power Off	30 minutes
Safety rating	CAT III 1000V / CAT IV 600V
Dimensions	250mm x 78mm x 40mm
Weight (net)	350g
Power supply	3 x 1.5V AAA (supplied)
Supplied with	Test Leads, K-Type Thermocouple & Carry Case
EAN	5060082544699



CAT IV Applicable to test and measuring circuits connected at the source of the building's low-voltage MAINS installation.

V. Meter Description

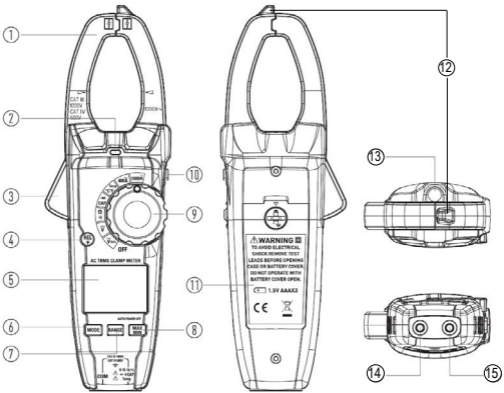

1. Current Clamp
2. Non-Contact AC Voltage Detector Light
3. Clamp Trigger
4. Relative / Backlight Button
5. LCD Display
6. **MODE** Button
7. **RANGE** Button
8. **MAX / MIN** Button
9. Rotary Function Switch
10. **DATA HOLD** / Flashlight Button
11. Battery Cover
12. Non-contact Voltage Detection Point
13. Flashlight
14. **COM** Input terminal
15. **V, Ω, Hz, %, , , CAP & TEMP** Input terminal

VI. Symbols Used on LCD Display

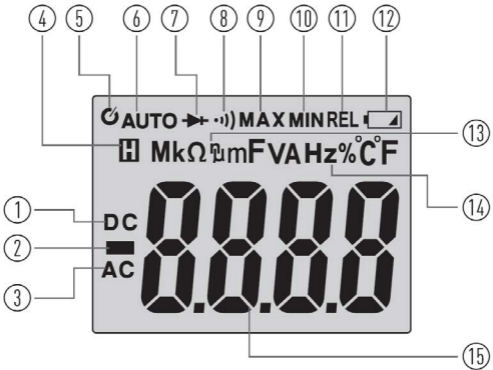

1. DC - Direct Current
2. Minus Sign
3. AC - Alternating Current
4. Data Hold Mode
5. Auto Power Off
6. Auto Range Mode
7. Diode Test Mode
8. Audible Continuity
9. Maximum
10. Minimum
11. Relative Mode
12. Low Battery
13. Units of Measure List
14. Frequency / Duty Cycle Test Mode
15. 4000 Count (0 to 3999) Measurement Reading

VII. Detailed Specifications: Range & Accuracy

Function	Range & Resolution	Accuracy \pm (% of reading+digits)
AC Current (50/60Hz)	400.0A	\pm (2.5% + 8 digits)
	1000A	\pm (2.8% + 8 digits)
AC Voltage (50-400Hz)	4.000V	\pm (1.5% + 5 digits)
	40.00V	
	400.0V	
	1000V	
DC Voltage	400.0mV	\pm (1.5% + 5 digits)
	4.000V	
	40.00V	
	400.0V	
	1000V	
Resistance	400.0 Ω	\pm (1.0% + 4 digits)
	4.000K Ω	\pm (1.5% + 2 digits)
	40.00K Ω	
	400.0K Ω	
	4.000M Ω	\pm (2.5% + 3 digits)
40.00M Ω	\pm (3.5% + 5 digits)	
Capacitance	40.00nF	\pm (4.0% + 20 digits)
	400.0nF	\pm (3% + 5 digits)
	4.000 μ F	
	40.00 μ F	
	400.0 μ F	\pm (5% + 5 digits)
	4.000mF	
	40.00mF	
100.0mF		
Frequency Sensitivity: =>5Vrms	9.999Hz to 99.99kHz	\pm (1.2% + 5 digits)
	Duty Cycle Sensitivity: =>5Vrms	10.0% to 90.0%
Temp (Type-K)	-20.0 to 1000 $^{\circ}$ C	\pm (3% + 5 $^{\circ}$ C)
	-4.0 to 1832 $^{\circ}$ F	\pm (3% + 9 $^{\circ}$ F)
(Probe accuracy not included)		

1. General Specifications

Clamp Size	Opening 1.4" (35mm) Approx.
Diode Test	Test current of 0.3mA typical; Open circuit voltage 3.2V DC typical
Continuity Check	Threshold $\leq 50 \Omega$; Test Current , 0.5mA
Low Battery Indication	"  " is displayed
Over-range Indication	"OI" is displayed
Measurements Rate	2 per second. Nominal
Input Impedance	10M Ω (VDC and VAC)
Display	4000 Counts LCD
AC Current	50-60Hz (AAC)
AC Voltage Bandwidth	50-400Hz (V AC)
Operating Temperature	5 to 40°C (41 to 104° F)
Storage Temperature	-20 to 60°C (-4 to 140° F)
Operating Humidity	Max 80% up to 31°C (87° F) decreasing linearly to 50% at 40°C (104° F)
Storage Humidity	<80%
Operating Altitude	7000ft. (2000 metres) maximum
Over Voltage	Category IV 1000V
Battery	3 x "AAA" 1.5V
Safety	For indoor use and in accordance with over-voltage Category II, Pollution Degree 2. Category II includes installation, appliance and portable equipment etc. with transient over-voltages less than the over-voltage of Cat. III.

NOTICES: Read and understand all warning and precaution statements listed in the safety section of this operation manual prior to using this meter. You should always set the function select switch to the OFF position when the meter is not in use.

2. Operation

Rotate the functional dial on the side of the DL6413 from the off position clockwise to the function required.

Device will automatically power off after approx: 30 Minutes. To temporarily disable the auto power off function, please follow the below steps:

- The rotary functional dial must be in the Off position.
- Press and hold the **MODE** button.
- Simultaneously, rotate the dial to the desired function.
- The “Auto Power Off” symbol will turn off.
- To reset, switch the meter to the off position.

3. AC Current Measurements

WARNING: Ensure that the test leads are disconnected from the meter before making current clamp measurements.

- Rotate the function dial to the **1000A AC** or **400A AC** range.
- If the range of the measured current is not known, please select the higher **1000A** range first then move to the lower range if necessary.
- Press the trigger to open jaw, fully enclose the single conductor to be measured aligning with the centre markers making sure the jaw is fully closed once the conductor is inserted.
- Please use the Relative Zero feature if required, see section 15 for further information.
- The measured current value will be indicated on the main LCD the display.

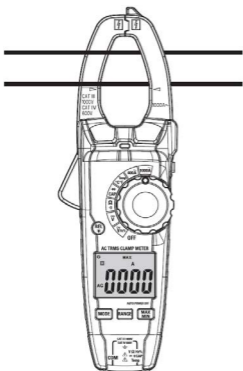

Incorrect

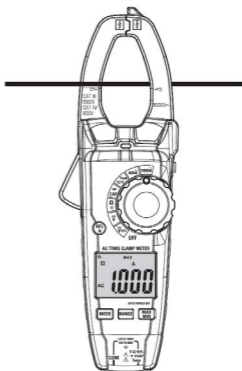

Correct



4. AC/DC Voltage Measurements

- Insert the black test lead into the negative **COM** terminal and the red test lead into the positive **V** terminal.
- Rotate the functional dial to the either **ACV** or **DCV** position.
- Connect the test leads in parallel to the circuit under test.
- The measured voltage value will be indicated on the main LCD the display.

5. Resistance Measurements

- Insert the black test lead into the negative **COM** terminal and the red test lead into the positive resistance terminal represented by the Ω symbol.
- Rotate the function dial to the Ω  position, the DL6413 is default set to resistance measurement.
- Touch the test probe tips across the circuit or component under test. It is best to disconnect one side of the device under test so the rest of the circuit will not interfere with the resistance reading.
- The measured resistance value will be indicated on the main LCD the display.

6. Continuity Measurements

- Insert the black test lead into the negative **COM** terminal and the red test lead into the positive continuity terminal represented by the  symbol.
- Rotate the function dial to the Ω  position, the DL6413 is default set to resistance measurement.
- Press the **MODE** button until “  ” appears at the top of the LCD display. “OL” will appear in the main display.
- Touch the test probes together to conduct a pre-test of the clamp meter. If the continuity buzzer sounds, and records a low ohm reading, the clamp meter is functioning correctly. An open circuit will display “OL” in both polarities.
- The continuity buzzer will only sound if the measured resistance is $< 50\Omega$.

7. Diode Measurements

- Insert the black test lead into the negative **COM** terminal and the red test lead into the positive diode terminal.
- Rotate the function dial to the **➔** CAP position, the DL6413 is default set to diode measurement.
- Touch the test probes to the diode under test. Forward voltage will indicate 0.4V to 0.7V. Reverse voltage will indicate "OI" Shorted devices will indicate near 0mV and an open device will indicate "OL" in both polarities.

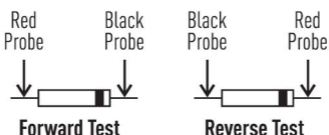

8. Capacitance Measurement

WARNING: To avoid electric shock, disconnect power to the unit under test and discharge all capacitors before taking any capacitance measurements. Remove the batteries and unplug the supply cables.

- Insert the black test lead into the negative **COM** terminal and the red test lead into the positive continuity terminal represented by the CAP symbol.
- Rotate the functional dial to the **CAP ➔** position, the DL6413 is default set to diode measurement.
- Press the **MODE** button until " **CAP** " appears at the top of the LCD display.
- Touch the test leads to the capacitor that is being tested.
- The measured capacitance value will be indicated on the main LCD the display.

9. Frequency or % Duty Cycle Measurements

- Insert the black lead into the negative **COM** terminal and the red test lead into the positive terminal represented by Hz/%.
- Rotate the functional dial to the **VAC/Hz/%** position, the DL6413 is default set to diode measurement.
- Press the **MODE** button until " **Hz or %** " appears at the top of the LCD display.
- Touch the test probe tips to the circuit under test.
- The measured frequency or % duty cycle value will be indicated on the main LCD display.

10. Temperature Measurements

WARNING: To avoid electric shock, disconnect both test probes from any source of voltage before making a temperature measurement.

- Insert the 4mm to K-Type adaptor into the negative **COM** and the **V** inputs on the base of the clamp meter, making sure to observe the correct polarity.
- Connect the supplied K-Type thermocouple or optional K-Type accessory into the adaptor observing the correct polarity.
- Rotate the function dial to the **TEMP** position, the DL6413 is default set to °C measurement.
- Press the **MODE** button until either “°C or °F” appears at the top of the LCD display.
- Touch the Temperature Probe head to the target object that you required to conduct the temperature measurement. Keep the probe touching the part under test until the reading stabilises (Approx. 30 seconds).

WARNING: To avoid electric shock, be sure the thermocouple has been removed before changing to another measurement function.

11. Non-Contact & Direct-contact AC Voltage Detection

WARNING: Risk of Electrocution. Before use, always test the Voltage Detector on a known live circuit to verify this feature is working correctly.

The DL6413 has the ability to measure Non-contact Voltage via the detection point positioned on the top of the clamp jaw, or, via Direct-contact connection when Voltages >50V are detected on either the negative **COM** black test lead, or the positive **V** red test lead on any rotary dial test position.

- Rotate the functional dial from the off position to AC Voltage, although the function will detect voltage in any rotary switched position.
- For **Non-contact detection**, the live conductor will need to be <10mm from the detection point on the top of the clamp jaw. Detection may not be possible when measuring metal plated switches or sockets.
- If AC voltage is present, the detector light (V.2 page 7) will illuminate Red.
- **Caution:** Non-contact detection is only an indication to the presents of voltage, direct contact with an approved Voltage Indicator should be used in conjunction with the Safe Isolation Procedure.

11. Non-Contact & Direct-contact AC Voltage Detection (continued)

- For **Direct-contact detection**, a direct connection to the live conductor with either the Red or Black Test Probe will be needed.
- If AC voltage is present >50V, the detector light (V.2 page 7) will illuminate Red.
- **Caution:** Direct-contact detection on the DL6413 is only an indication to the presents of voltage, direct contact with an approved Voltage Indicator should be used in conjunction with the Safe Isolation Procedure.

NOTE: The conductors in electrical cables are often twisted. For best results, slide the non-contact detection point along a length of the cable and ensure the placement of the tip is in close proximity to the live conductor.

NOTE: The detector is designed with high sensitivity. Static electricity/ external sources of energy may randomly activate the sensor. This is deemed to be normal operation.

12. Buttons - Mode Button

Here are all the **MODE** multiple fuction feature groups available to select: AC / Hz / % | OHM / Continuity / Diode / CAP | °C / °F.

13. Buttons - Range Button

When the meter is first turned on, it automatically goes into Auto Ranging mode. This automatically selects the best range for the measurements being made and is generally the best mode for most measurements. For measurement situations requiring that a range be manually selected, please perform the following:

- Press the **RANGE** button. The “Auto Range” display indicator will turn off and the DL6413 will enter “Manual Range” mode.
- Press the **RANGE** button to step through the available ranges until you select the range you require.
- To reset the DL6413 back into “Auto Range” mode, press and hold the **RANGE** button for 2 seconds to exit the “Manual Ranging” mode and return to full auto.

14. Buttons - MAX/MIN Button

- Momentarily press the **MAX/MIN** Button to activate the **MAX/MIN** mode on the meter. On the first press, the “**MAX**” indicator will appear on the LCD display. The meter will display and hold the maximum reading and will update when a higher reading or maximum recorded value occurs.
- Momentarily press the **MAX/MIN** Button again to view the lowest reading. The “**MIN**” indicator meter will appear on the LCD display. The meter will display and hold the minimum reading and will update when a lower reading or minimum recorded value occurs.
- Once the minimum and maximum recording have been captured, a single press of the **MAX/MIN** button again will enable you to toggle between the **MAX/MIN** reading.
- Press and hold the **MAX/MIN** Button to end **MAX/MIN** and return to normal operation.

15. Buttons - REL / Backlight Button

REL “Relative Mode” mode allows you to measure the relative difference between a stored reference value and a new measurement. When you activate the REL mode, the meter stores the current reading as a reference value. This is particularly useful if you want to zero out a baseline measurement, such as background noise or an initial offset. Once the reference value is set, any new measurement will be displayed as the difference between the current reading and the stored reference value.

- A short press of the REL button will toggle this feature on/off indicated by “REL” on the LCD display. A long press of the REL/Backlight button will turn the backlight on/off.

Zeroing Out Offsets: If your meter has a small offset or if there is background noise, specifically static on DC, you can use REL mode to nullify these effects, making it easier to see small changes or precise measurements.

Comparative Measurements: It allows you to compare a new measurement directly against a previous one without needing to manually subtract the values.

16. Buttons - Data Hold/Flashlight

- To hold the measured reading on the LCD display, press the data hold button. The data hold button is located on the right side edge of the meter. While data hold is active, a "H" icon will be displayed on the LCD. Press the data hold button again to return to normal operation.
- Long press this button will turn on the ultra bright LED flashlight, another long press will turn the flashlight off.

17. Battery Replacement

- Make sure all test leads are disconnected and the clamp jaw is empty.
- Make sure the meter is turned to the off position
- Turn the meter so it is facing down on a protective surface.
- With a small coin, rotate the captive screw a half turn either clockwise or anticlockwise until the indicating arrow points towards the unlock symbol.
- Open the battery compartment.
- Replace the Requires Three "AAA" 1.5V Battery.
- Re-assemble the battery compartment cover.
- Rotate the captive screw with a small coin until the indicating arrow points towards the lock symbol.

18. Maintenance & Cleaning

The maintenance and other services of this instrument must be carried out by the manufacturer or an approved service centre so not to invalidate the warranty. Test leads are classed as a wear and tear item and are available to purchase as an accessory. Please contact product support for more information. The outer casing should be regularly cleaned with either a dry or slightly damp cloth. Do not use detergents, especially if they contain abrasives or solvents.



19. Warranty & Calibration

Di-LOG instruments are subject to stringent quality controls. If in the course of normal daily use a fault occurs we provide a 24 month warranty (only valid with proof of purchase). Faults in manufacture and material defects will be rectified by us free of charge, provided the instrument has not been tampered with and returned to us unopened. Damage due to dropping, abuse or misuse are not covered by the warranty.

Product Support

support@dilog.co.uk



To maintain the specified accuracy of the measurement results, the instrument must be recalibrated at regular intervals by Di-LOG. Di-LOG service partner, Re-CAL Calibration, are the only authorised agent with the facility to adjust and service the DL6400 series clamp meter. We recommend an annual recalibration period from the date of purchase.

Service & Calibration

www.recal.biz



Di-LOG Ltd

Unit 28 Wheel Forge Way
Trafford Park
Manchester M17 1EH
UK

Tel: +44 (0)161 877 0322
Email: sales@dilog.co.uk
Website: www.dilog.co.uk

Di-LOG

...measurably better

AC TRMS CLAMP METER Instruction Manual

Register your product with us to
keep in contact with the latest
updates and service reminders.



www.dilog.co.uk/register

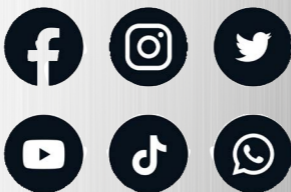

@Di-log Group

Stay connected with us and be the first to know about our latest news and updates by following us on our social media channels.